

# 88 5179 30C Round Table

## IMPORTANT NOTE

Carefully remove all the parts from the carton and put them individually on a soft cloth to prevent scratches or other damages occurring to the wood parts.

We have taken great care in the design of this product and request that you carefully and strictly follow our assembly instructions to ensure a completed product as it was designed.

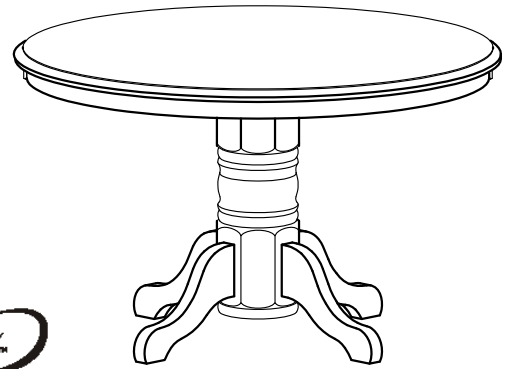

Casual Attire For Today's Home

## PART LIST

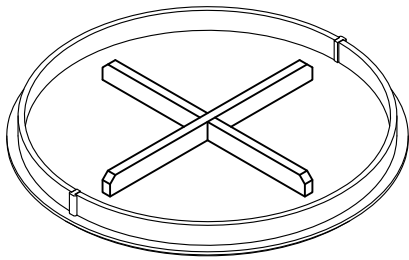

A.  
Table Top  
1pc.

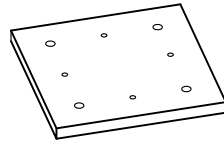

B.  
Connector Panel  
1pc.

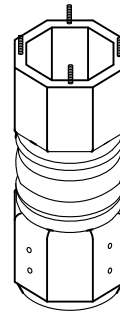

C.  
Post  
1pc.



D.  
Table Legs  
4pcs.

## HARDWARE LIST



1  
Flat Washer  
16pcs.



2  
Spring Washer  
16pcs.



3  
Nut  
12pcs.

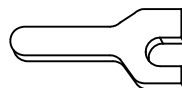

4  
Key Wrench  
1pc.



5  
Bolt  
4pcs.



6  
Hex Wrench  
1pc.

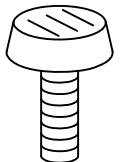

7  
Floor Leveler  
4pcs.

**IMPORTANT NOTE**

\*Do not tighten up all of the nuts or bolts until all parts are properly assembled.

## STEP 1

Attach Connect Panel (B) to Post (C), using Flat Washers, Spring Washers and Nuts

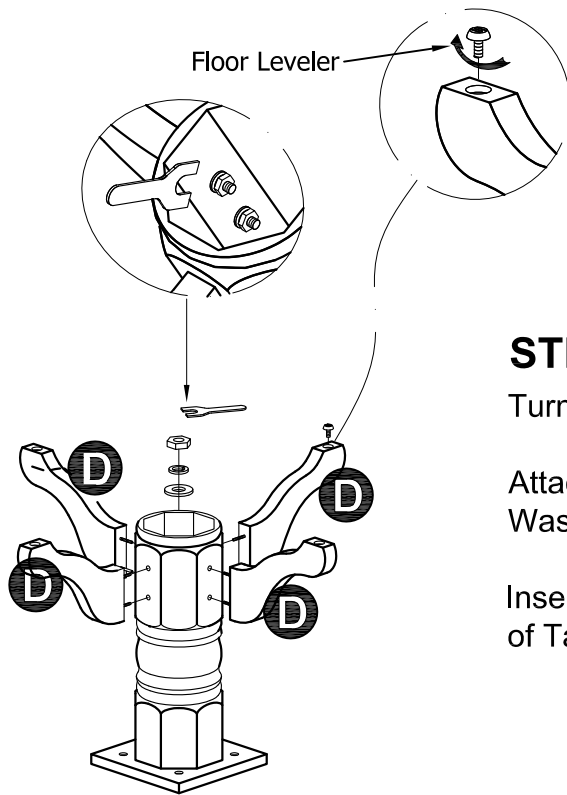
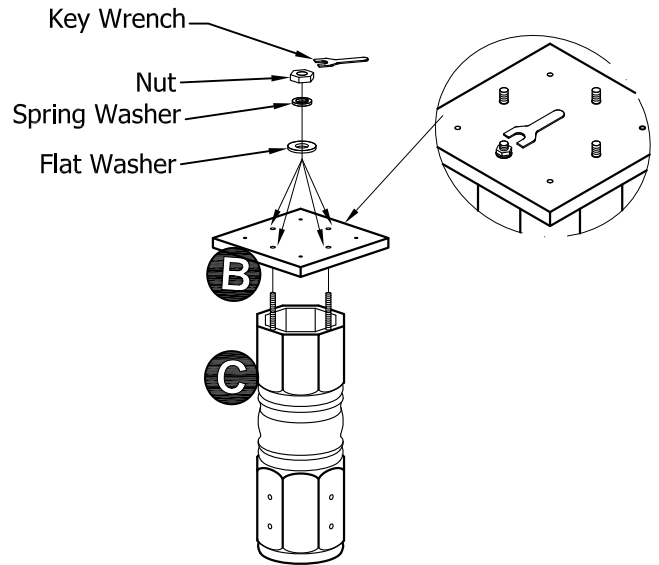

## STEP 2

Turn the unit upside down on the soft cloth.

Attach Table Leg (D) to the unit, using Flat Washers, Spring Washers and Nuts.

Insert floor levelers into the pre-drilled holes of Table Leg (D).

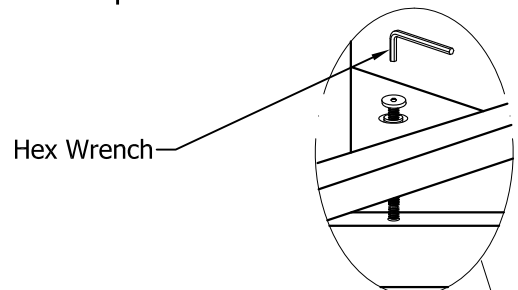

## STEP 3

Place the Base Unit in step 2 on to Table Top (A) with Flat Washers, Spring Washers and Bolts.

Turn the assembled unit to it's normal position.

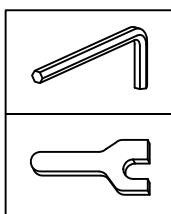

Please keep the Key Wrench and the Hex Wrench as you may need to retighten the table in the future.

